



saxun[®]

| BIOCLIMATIC
PERGOLAS

saxun®





Enjoy life outdoors

ALL YEAR ROUND

Bioclimatic pergolas by Saxun allow you to enjoy life outside all year round. They offer a variety of possibilities so that you can enjoy your terrace or garden as if they were another room in your home.

They regulate the temperature of the room in a natural way, while protecting it from solar radiation, rain, wind or snow.

Pergolas are the best solution to increase the living area of all kinds of hotels and restaurants. And all of that without the need for construction work.

Because when it comes to enjoying life outdoors, with Saxun it's possible.

Why choose Saxun bioclimatic pergolas?

Design

Our pergolas offer a modern and timeless design, with minimalist lines, which fits perfectly with every architectural style. The ideal solution for terraces or gardens in homes, hotels and restaurants.

Quality of life and wellness

Bioclimatic pergolas with which you can create new environments that will promote your freedom and privacy. Solar protection systems that will allow you to enjoy life outdoors at any time of the year, with the quality assurance that a brand like Giménez Ganga can grant.

Savings in energy and costs

They manage and save energy, since they regulate the temperature of the room in a natural manner. At the same time, they will protect it from solar radiation, rain, wind or any other natural elements.

Versatility and functionality

Saxun gives you the chance to increase the living area of your home or business without the need for construction work, since our pergolas are supported by their own structures. They have different types of mounting, as well as modulation options. In this way, a customised solution can be created for each project, allowing them to adopt different shapes and sizes that can adapt the different structures.

Customisation

The broad range of colours and finishes we offer you, together with the many accessories and products by Saxun that can be installed, allow a high degree of customisation. It is the best way to adapt to the different aesthetic and functional requirements that are needed nowadays.





01 INSTALLING 3 PERGOLAS WITHOUT COLUMNS

Installation of 3 pergolas with white textured powder coated, placed on an existing concrete structure around the pool.

02 INSTALLING PERGOLA WITHOUT COLUMNS

Installing a pergola without columns with an adapted structure to mount it between walls.

03 INSTALLING 2 PERGOLAS WITH 2 COLUMNS

Installing 2 pergolas with 2 columns with direct mounting on wall and free-flow drainage, finished with German silver. The installation is complete with the integration of 2 Wind Screen with profiling in silver and with Screen 5500 fabric.



saxun®

New spaces

Saxun's bioclimatic pergolas team up with natural light in order to create new spaces, which are perfectly illuminated and protected.

A tailored system that fits in any context and increases the living space, creating a comfortable environment.





INSTALLING 17 PERGOLAS IN A MARINA

Installing 17 pergolas in Denia Marina (Alicante), made up of 16 pergolas with 2 columns and 1 pergola with 4 columns, finished in matt RAL 9016.

saxun®



*Casting
shadows*



The pergola's orientable slats project shadows which, as the sun moves, become a geometric pattern in continuous movement.

A way to play with light that lets us change environments all the time, and choose the most appropriate for each case.

saxun®

BIOCLIMATIC PERGOLA

P-190

P-190 is a carefully designed pergola with modern lines. A solid aluminium structure with orientable slats, offering the best resistance against snow and rain loads, etc.

It has endless modulation possibilities, which added to the quality of its materials makes it the perfect solution for solar protection, ideal for adapting and enhancing every architectural style where.





Characteristics

Breathable, watertight cover
Orientable slats, from 0° to 135°.

Different mounting types
Tailored manufacturing.

Working slat dimensions
165x40 mm.

Maximum dimensions (type 4 columns)
High: 3,000 mm, wide: 4,200 mm, long: 6,200 mm.

Motorised operation

A 24Vdc motor (low voltage) provides better safety against electric shock. Additional earthing protection.

Registered perimeter sealing system against sideways rain and vibration due to gusts of wind

Channeling of rainwater

Free-flow drainage or slab channeling.

Safety

Hidden drains and electrical lines.

Materials

6063 T5 aluminium, stainless steel and polyacetal (POM).

Finishes

In accordance with specifications for Qualicoat, Qualideco and Qualanod. RAL colour, anodized or wood effect finishes are available.



Registered perimeter sealing

A **registered system** that works against sideways rain and prevents direct and/or reflected light from going through the joints between the slats and the frame.

Watertight system

There is a rubber sealing integrated into the slats, which ensures the watertightness of the pergola, since it does not allow water into the joints between slats.

At the same time, it cancels the noise created between the slats due to the vibration caused by wind.



Motorised operation

The pergola can be operated only by motorisation, using a 24 Vdc motor. This will also ensure your safety against electric shock, with the additional safety of earthing protection.

The motorised element is discretely hidden between the slats and the frame, promoting the beauty of the pergola.



ASSEMBLY TYPES

P-190 PERGOLA

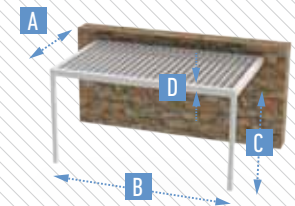
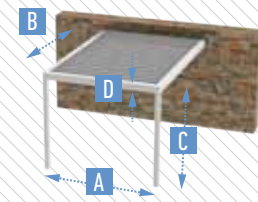
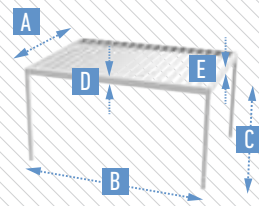
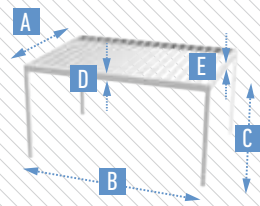

		4 COLUMNS	3 COLUMNS	2 COLUMNS PARALLEL TO WALL	2 COLUMNS PERPENDICULAR TO WALL
A	Maximum tested width	4,200 mm	4,200 mm	4,200 mm	4,200 mm
B	Maximum tested length (according to width and location)	6,200 mm	6,200 mm	6,200 mm	6,200 mm
C	Maximum height	3,000 mm	3,000 mm	3,000 mm	3,000 mm
D	Beam dimensions	220 mm	220 mm	220 mm	220 mm
E	Beam dimensions	220 mm	220 mm	220 mm	220 mm
F	Column dimensions	150x150 mm	150x150 mm	150x150 mm	150x150 mm
	Minimum inclination	No inclination	No inclination	No inclination	1%
	Type of drainage	Free-flow or slab channeling	Free-flow or slab channeling	Free-flow or slab channeling	Free-flow or slab channeling

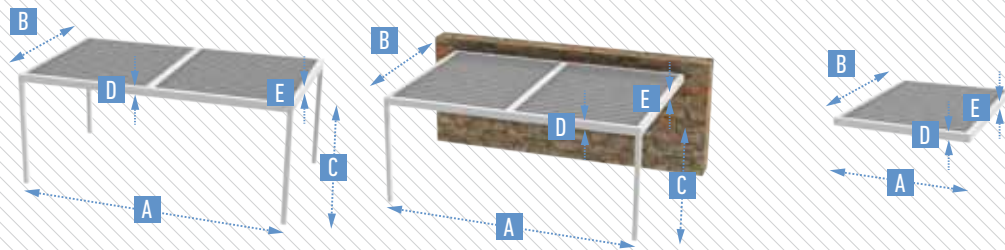

DUPLEX 4 COLUMNS	DUPLEX 2 COLUMNS	NO COLUMNS
7,000 mm	7,000 mm	4,200 mm
6,000 mm	6,000 mm	6,200 mm
3,000 mm	3,000 mm	-
300 mm	300 mm	220 mm
220 mm	220 mm	220 mm
* 150x150 mm	* 150x150 mm	-
No inclination	No inclination	No inclination
Free-flow or slab channeling	Free-flow or slab channeling	To be done by the client

* Fixing by means of surface mounting.



EXAMPLE OF INSTALLATION **P-190 PERGOLA**
4 COLUMN TYPE

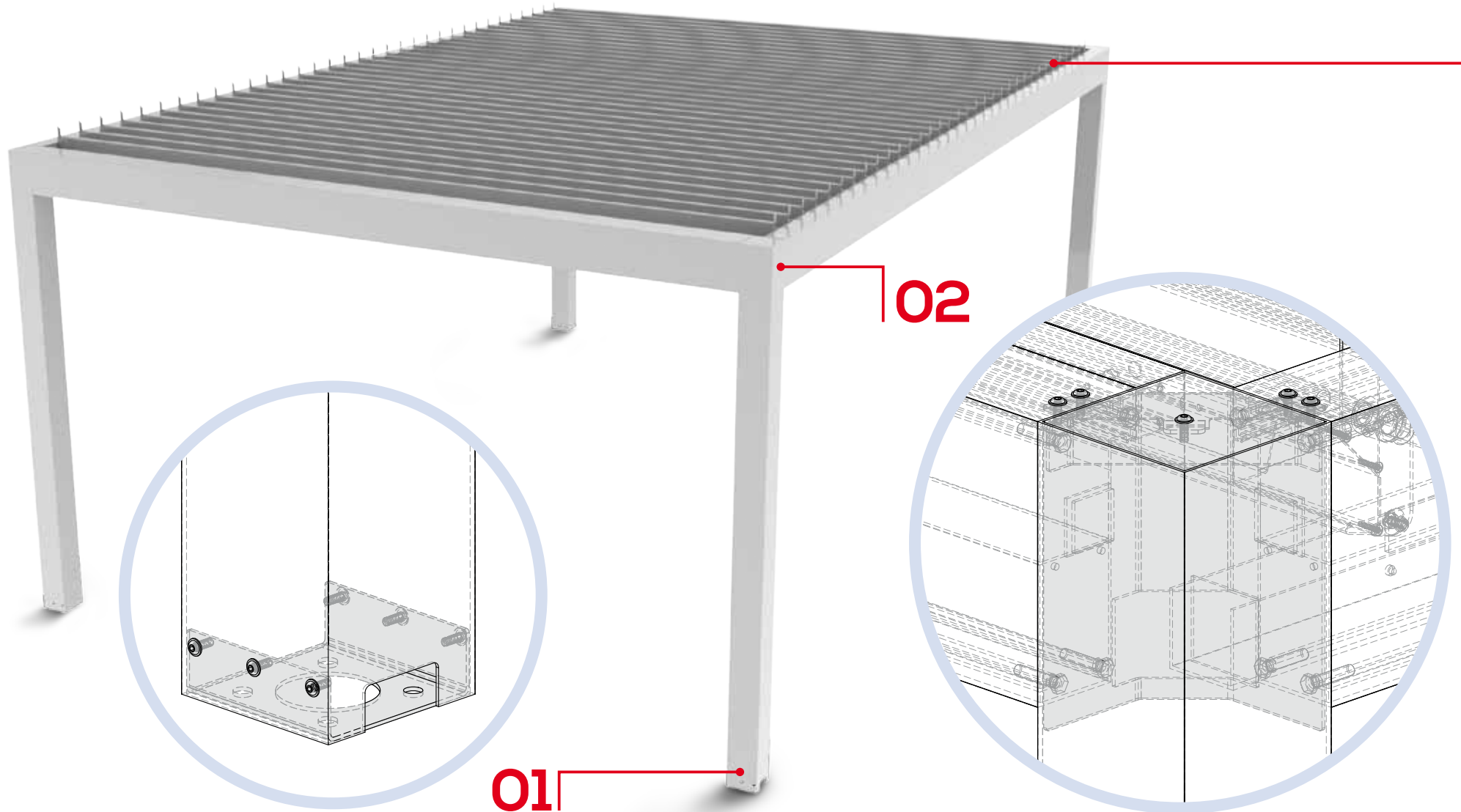

03

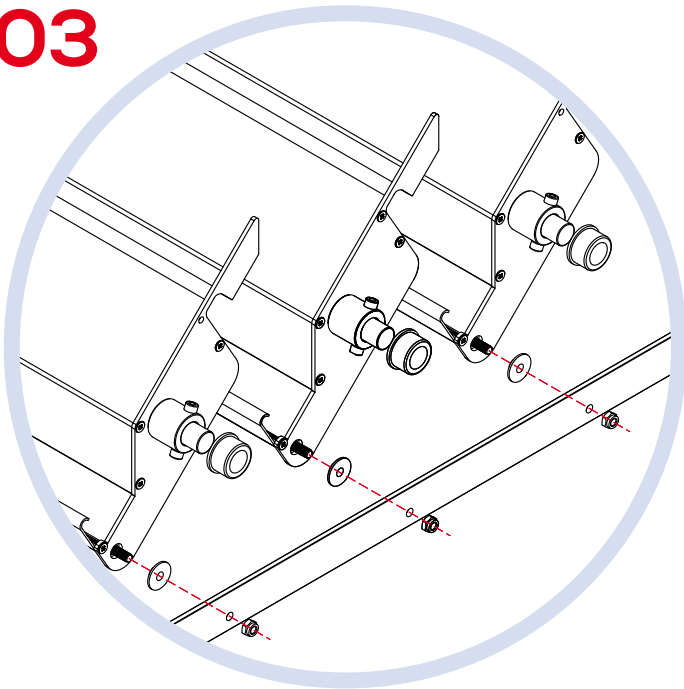

PROFILES **P-190 PERGOLA**
4 COLUMN TYPE

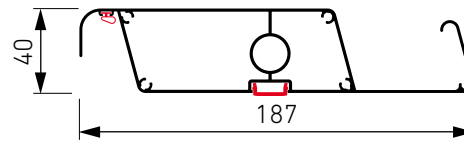

P-190 LED slat
■ **050189**

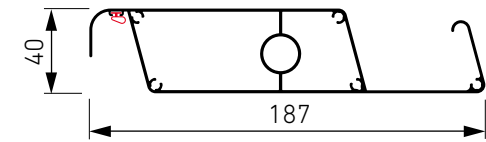

P-190 slat
■ **050188**

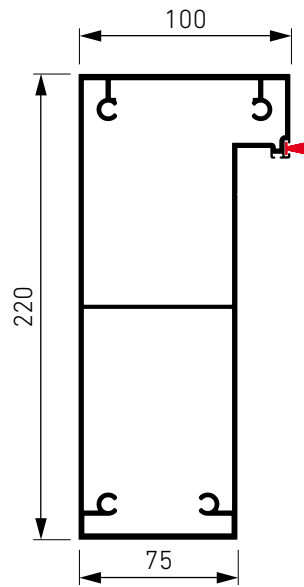

Beam P-220x100 mm
■ **023103**

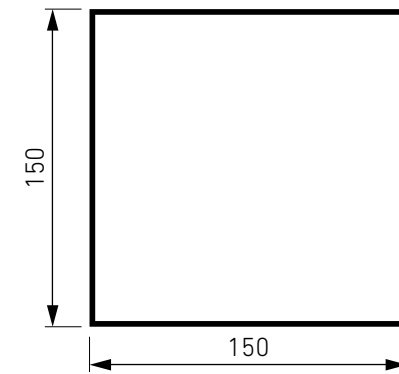

Column P-150x150x2,5 mm
■ **023101**

- 01** INSTALLING THE COLUMN BASE CLAMP
- 02** INSTALLING THE INNER REINFORCEMENT
- 03** EXPLODED VIEW OF P-190 SLAT

saxun®

BIOCLIMATIC PERGOLA

P-150 **new**

The new P-150 is a model with similar characteristics to P-190. It is designed with clean lines which lets it adapt to any architectural style.

This pergola has great advantages when it comes to installation. The mounting time is minimised, making it a quick and easy task, since some profiles simply clip into place and do not need screwing.

The mounting of the slats is also smoother, thanks to the retracting spring-loaded.



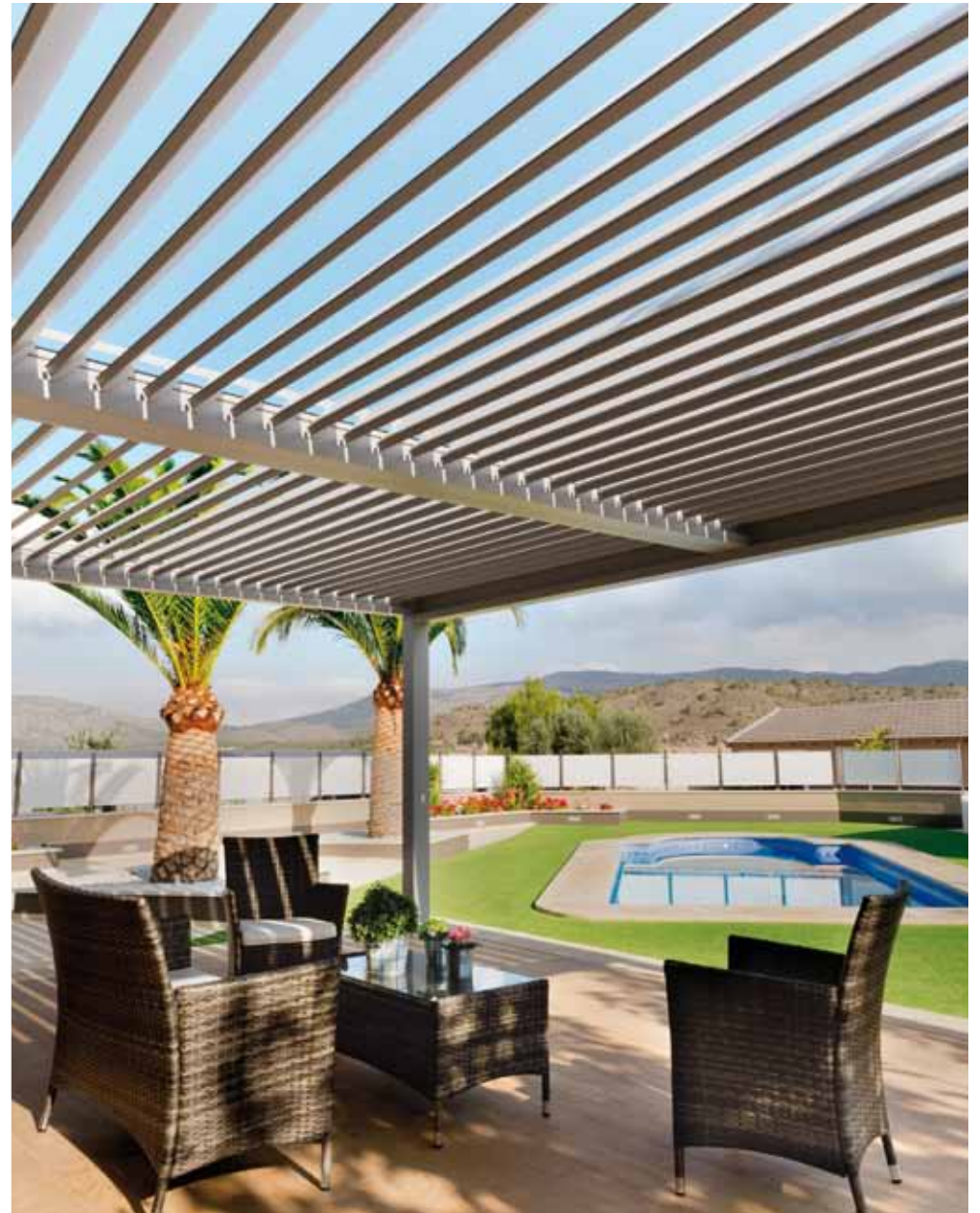

Characteristics

Breathable, watertight cover

Orientable slats, from 0° to 135°.

Different mounting types

Tailored manufacturing.

Working slat dimensions

150x35 mm.

Maximum dimensions (type 4 columns)

High: 3,000 mm, wide: 3,600 mm, long: 5,000 mm.

External motorisation

The motor, which works at 24Vdc (low voltage), also provides better safety against electric shock.

Registered perimeter sealing system against sideways rain and vibration due to gusts of wind

Easy mounting of components

The collector and adapter clip into place, without screws. The slat can also be installed quickly thanks to the retracting spring-loaded shaft.

Channeling of rainwater

Free-flow drainage or slab channeling.

Materials

6063 T5 aluminium, stainless steel and nylon fv UV filter.

Finishes

In accordance with specifications for Qualicoat, Qualideco and Qualanod. RAL colour, anodized or imitation wood finishes are available.



Registered perimeter sealing

A **registered system** that works against sideways rain and prevents direct and/or reflected light from going through the joints between the slats and the frame.



Component optimisation

This model's duplex installation, as well as the grouping of pergolas, allow columns to be shared, resulting in a very efficient design.



External motorisation

The motor in the P-150 model is located in the upper part of the pergola, on the outside, so it is not visible from inside.

Its IP67 ensures a complete guarantee with regard to outdoor exposure, against rain and suspended particles such as dust, etc.

This arrangement makes it possible to share a motor when there are groups of pergolas, or in duplex pergolas.

ASSEMBLY TYPES

P-150 PERGOLA

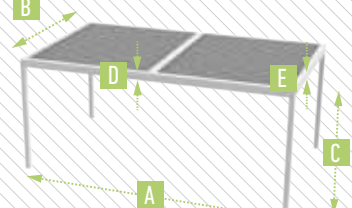
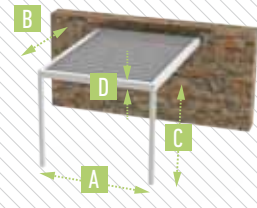
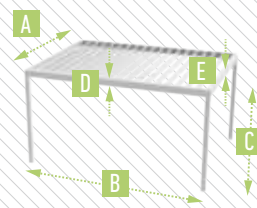
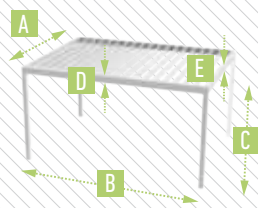

		4 COLUMNS	3 COLUMNS	2 COLUMNS PARALELL TO WALL	DUPLEX 4 COLUMNS
A	Maximum tested width	3,600 mm	3,600 mm	3,600 mm	6,000 mm
B	Maximum tested length (according to width and location)	5,000 mm	5,000 mm	5,000 mm	5,000 mm
C	Maximum height	3,000 mm	3,000 mm	3,000 mm	3,000 mm
D	Beam dimensions	180 mm	180 mm	180 mm	242.5 mm
E	Beam dimensions	180 mm	180 mm	180 mm	180 mm
F	Column dimensions	* 125x125 mm	* 125x125 mm	* 125x125 mm	* 150x150 mm
	Minimum inclination	No inclination	No inclination	No inclination	No inclination
	Type of drainage	Free-flow or slab channeling	Free-flow or slab channeling	Free-flow or slab channeling	Free-flow or slab channeling

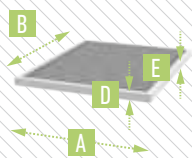
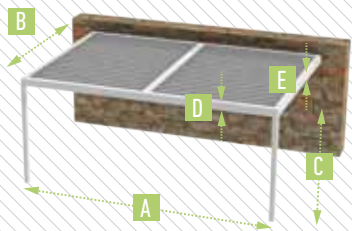

DUPLEX
2 COLUMNS

NO
COLUMNS

6,000 mm	3,600 mm
5,000 mm	5,000 mm
3,000 mm	-
242.5 mm	180 mm
180 mm	180 mm
* 150x150 mm	-
No inclination	No inclination
Free-flow or slab channeling	To be done by the client

* Fixing by means of surface mounting.



EXAMPLE OF INSTALLATION **P-150 PERGOLA**
4 COLUMN TYPE

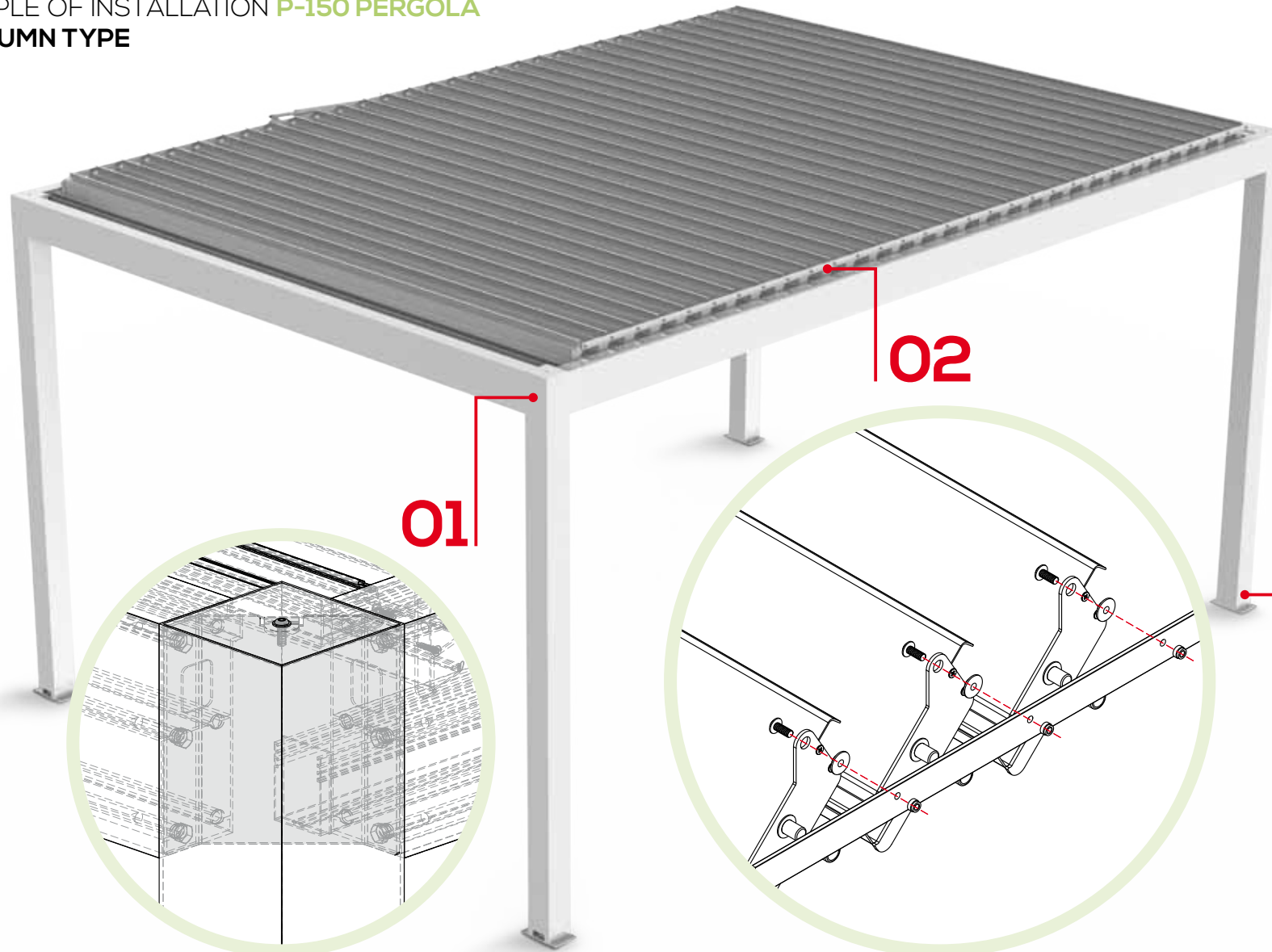

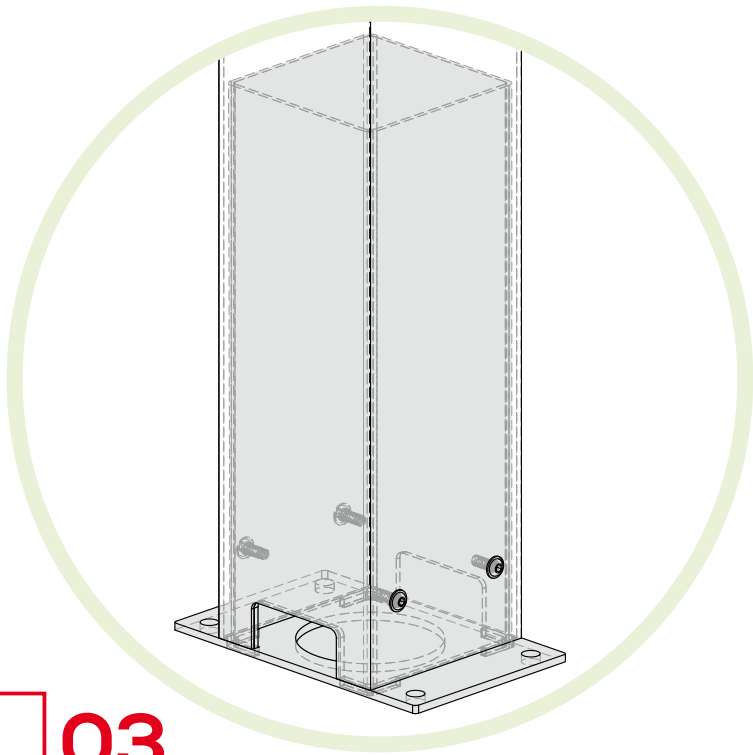

PROFILES **P-150 PERGOLA**
4 COLUMN TYPE

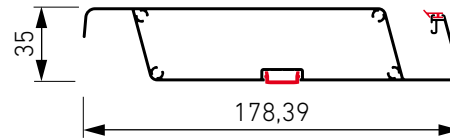

P-150 LED slat
 ■ 050210

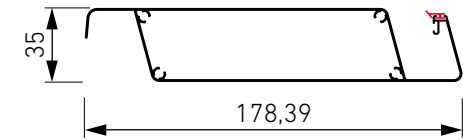

P-150 slat
 ■ 050209

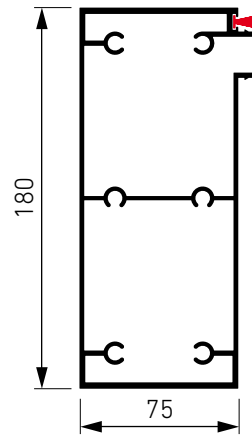

Beam P-180x85 mm
 ■ 050206

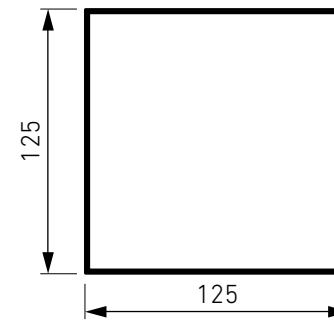

P-125x125 mm column
 ■ 050205

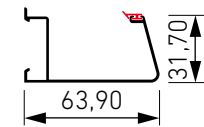

Clipping collector
 ■ 050208

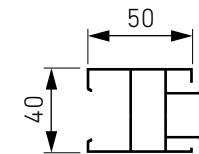

Clipp-on adapter
 40x50 mm SOFT
 ■ 050218

- 01 INSTALLING VERTICAL BRACKETS FOR THE P-180 BEAM
- 02 EXPLODED VIEW OF P-150 SLAT
- 03 INSTALLING THE S SURFACE BRACKET

saxun®



Corners to discover

Gardens and terraces are an essential part of our houses, for we do not distinguish between them in our home.

Our bioclimatic pergolas allow comfort and well-being across the whole set-up, connecting them and making them bigger.



PERGOLA 2 COLUMNS

Pergola with 2 columns perpendicular to the wall with water channeling through free drainage.

Installation for the remodelling of an old town house.

2 COLUMNS PERGOLA

Bioclimatic pergola with 2 columns with direct wall mounting. This pergola is equipped with 4 strips of LED light (warm light), 1 Bluetooth music system, a 2,000 W infrared heater. Sealing is complete upon installation of 4 Wind Screen XL.





Tradition and modernity

Its linear and timeless design adapts to the most modern or contemporary architectural styles, but also to the most traditional.



ORIENTABLE SLATS

The roof of our pergolas is made of completely automated orientable slats. A mobile roof that allows a range of inclinations from 0° to 135°, which permits the optimisation of sunlight, making the most of daylight hours during the day.

It protects us from the most harmful solar radiation, while refreshing the area with natural convection whenever it is necessary. The slats are provided with a rubber seal, which prevents water from getting inside the pergola when it rains.

INCLINATION DEGREES

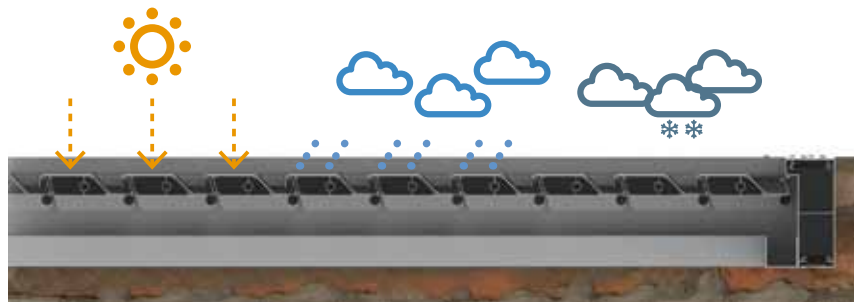

0°

The roof is closed and offers total protection against the most harmful solar radiation, as well as the most extreme weather.

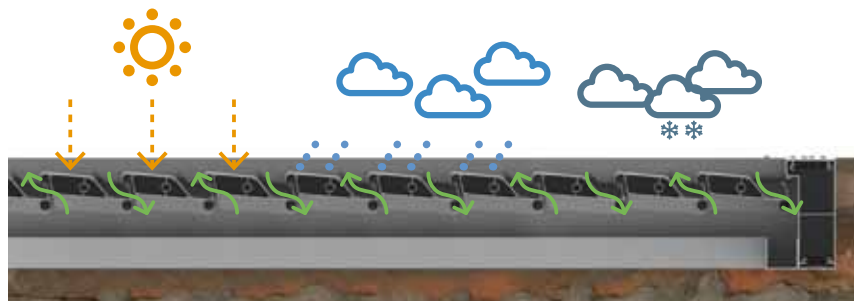

5°

It enables the perfect ventilation of the room, making a shade when it is sunny, or protecting from the water when it rains.

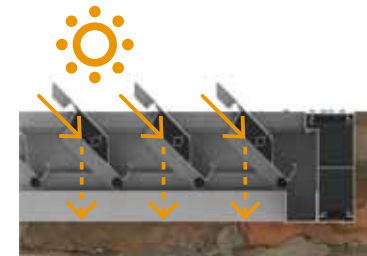

45°

You will enjoy natural ventilation, controlling the direction and intensity of sun rays.

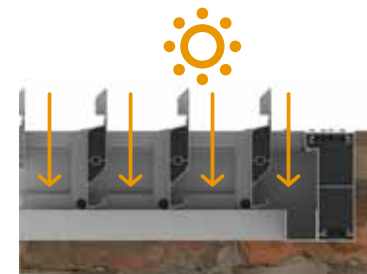

90°

The slab opening allows making total use of the sun, even on days with not a lot of light.

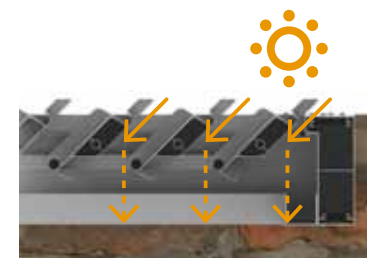

135°

The maximum inclination that lets sunlight in when the sun is already setting.

COLLECTING RAINWATER

The design of the P-190 and P-150 slats allows rainwater to be collected in order to reuse it. Water is channelled towards the lateral frames, without the need to slope to drain.

In this way, it also helps to protect the furniture located under the pergola, because it prevents stored rainwater from falling onto your furniture once the slats are moved again, using different sensors.

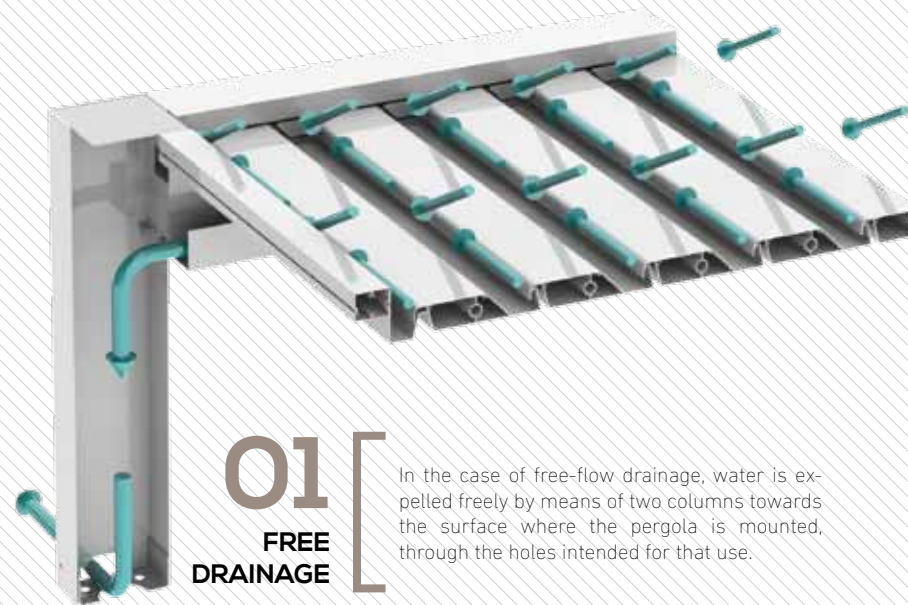

In the case of free-flow drainage, water is expelled freely by means of two columns towards the surface where the pergola is mounted, through the holes intended for that use.

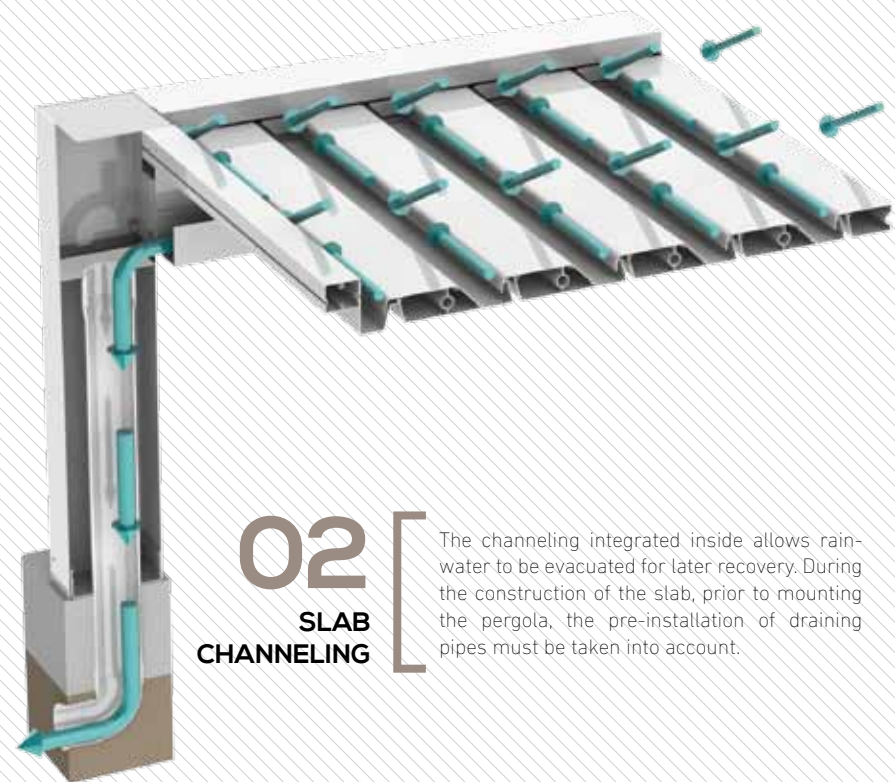

The channeling integrated inside allows rainwater to be evacuated for later recovery. During the construction of the slab, prior to mounting the pergola, the pre-installation of draining pipes must be taken into account.

A safe bet for your business



Given the huge amount of possibilities they offer, Saxun's pergolas are the perfect solution for all kinds of projects in the HORECA sector, either in hotels, restaurants or cafés. The lack of need for brickwork, and their conception as collapsible structures allow the installation to be quick and easy.

A wide range of colours and finishes, as well as accessories and complementary items, enable the creation of new and attractive spaces for your clients to enjoy being outdoors in any season of the year, at any time of day.





2 COLUMNS PERGOLA

Installing a pergola with 2 columns perpendicular to wall with glass enclosing to create an intimate and sheltered atmosphere for your clients.

Although the pergola is right beside the beach, its aluminium construction using 6063 T5 alloy, with a Qualicoat or Qualanod surface finish and durable stainless steel accessories, guarantees reliable durability.

saxun®





INSTALLING 9 PERGOLAS IN A RECREATION AREA

Self-supporting structure with 8 simple models and 1 duplex model, protecting a total of 200 m², where 16 box awnings from the Iris model have also been installed in order to increase the protected area.

On the edges, the vertical Wind Screen and Descend awning have also been combined.

saxun®

OPTIONAL PRODUCTS

Saxun's bioclimatic pergolas can be equipped with accessories to optimise their use. Accessories with which you can achieve a higher degree of customisation, completely adapted to your needs.



LED lighting

This type of illumination distributes light homogeneously. It adapts to different requirements, to the need to create different atmospheres, since it allows the regulation of light.

This lighting is integrated into the slat itself, and leaving no visible connection. Option of warm or neutral light.



somfy®

Somfy automatic systems

The use of the pergola is very easy and comfortable, and thanks to the automatic systems by Somfy, you will also be able to manage its operation remotely.

TaHoma will allow you, regardless of where you are, to control your pergola together with the rest of elements in your home or business, in a quick and easy way.

Thanks to the download of the app for your mobile, tablet or computer, and with an Internet connection, you will change the orientation of the slats, turn on the lighting (and change its intensity) and the heating, and operate your Wind Screen or awning, which should have a wind sensor so as not to wear down the structure.

Wind Screen

Our Wind Screen range, besides offering protection and a higher degree of privacy, allow sunlight to keep entering through the upper part of the pergola.

It is a blind, designed especially for outdoors use which, thanks to its system of zipper rails, can tolerate strong gusts of wind.

The opening and closing of the Wind Screen can be done through the same automatic system that controls the operation of the pergola, ensuring a perfect closing.

With a great aesthetic value, and thanks to the design of the new boxes, the Wind Screen adapts perfectly to the most demanding requirements. But the level of customisation of your blind will be unlimited, thanks to the wide range of fabrics and the many colours and finishes offered by Saxun.

Infrared heating equipment

Thanks to the installation of these heating systems, you can extend your stay across the day, and also make use of the pergola even on the coldest days.



Isolation P-150 slat

This piece of expanded polystyrene mitigates the sound of rain when it hits the surface of the slat.



Bluetooth sound system

Listening to music outdoors is really easy. You will be able to play music from any Bluetooth device, smartphone or tablet through the wireless connection in a simple manner, needing only an App to manage this system.

saxun®





PERGOLA 4 COLUMNS

Bioclimatic pergola with 4 columns and matt bronze finish.

2 folding Majorcan blinds with 4 elements and D-7 moving slats, also in matt bronze, have been attached to the pergola.



Saxun's bioclimatic pergolas can be lacquered in any colour from the RAL chart. The coating of the slats, columns, beams and other component profiles that make it up, is done in our facilities in Sax (Alicante). Advanced technology to provide a high-quality surface that complies with the requirements of the European Qualicoat certification.



FINISHES

We offer many colours and finishes for our pergolas, with a wide range of **colours in the RAL chart**, **anodised** and **wood-finish lacquers**, and **layered** or **textured colours**.

Colours and finishes with the guarantee required for the major seals of quality.



TEXTURED COLOURS

These finishes, apart from offering an elegant touch, also provide perfect resistance against climatic agents and UV radiation.

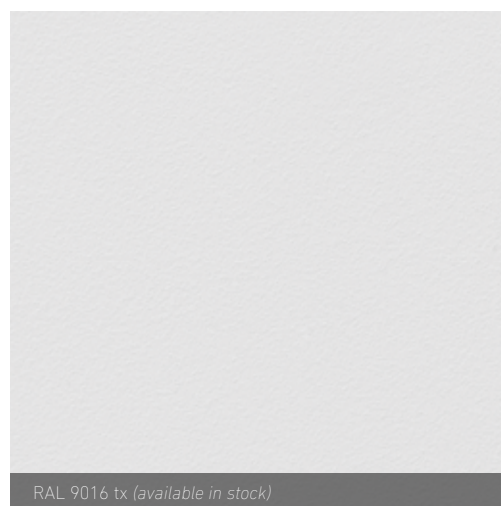

RAL 9010 tx



RAL 1013 tx



RAL 7035 tx



2150 grey sable tx

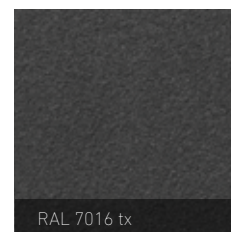

RAL 7016 tx

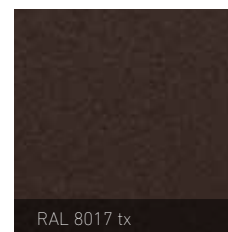

RAL 8017 tx

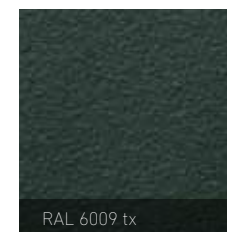

RAL 6009 tx

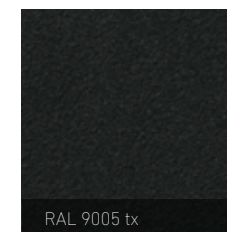

RAL 9005 tx

NOTE

The shades of these colours are for guidance only. There could be a difference from the actual colour due to the printing process.



Wind test for the P-190 model in the Giménez Ganga laboratory.

Wind load



P-190 and P-150

Standard UNE-EN 13659:2004+A class 6 (aprox. 112 km/h) tested up to 190 km/h without breaking within test bench parameters.

TESTS

Our pergolas, just like the rest of our products, are subjected to a variety of tests in our labs in order to check their resistance and behaviour under every type of circumstance.

Tests done following the requirements of International Standards involving parameters such as wind resistance and rainfall or snowfall demonstrate the excellent performance of our bioclimatic pergolas against the most adverse conditions.

Snow load



P-190

≤100 kg/m² (including its own weight)
Standard EN-1999 EUROCODE 9 aluminium structures project.

P-150

≤65 kg/m² (including its own weight)
Standard EN-1999 EUROCODE 9 aluminium structures project.

Rain load



P-190 and P-150

Standard UNE-EN 12056-3, (0,03 l/s max.) constant heavy rain aprox. 108 l.m²/h (structures + slats).



PERGOLA 2 COLUMNS

Pergola with 2 columns perpendicular to wall. The structure is powder coated in RAL 7016, whereas the slats are in RAL 9016, both colours in textured finish.



Giménez Ganga is a Spanish company, that since 1959 has been offering solar protection solutions, enclosures and decorations.

A company in constant growth, enjoying significant national and international expansion, that has become a household name as a manufacturer of rolling shutters, rolling doors, louvers, window and door shutters, mosquito screens, curtains and blinds, awnings and pergolas.

Our great geographical diversification, together with a brilliant team and a powerful technological and productive capacity allows us to be at the forefront of our industry to offer our clients products with optimal quality and guaranteed service.



Human and technological potential

Giménez Ganga designs and manufactures entirely Saxun's bioclimatic pergolas. From the initial phase of each project in our R+D+i department, to the extrusion of all the profiles that make up our products, everything carried out in our facilities in Sax.

3 lines of high performance extrusion provide the production of all the aluminium profiles sold by Giménez Ganga, among them the ones related to our pergolas.



saxun®

Giménez Ganga, S.L.U.

Polígono Industrial El Castillo
C/ Roma, 4
03630 Sax (Alicante) Spain

t. (+34) 965 474 050 | 965 474 205
f. (+34) 965 474 563

info@saxun.com

saxun.com

All the contents of this catalogue (including, but not limited to, the texts, photographs, graphics, images and other contents) are owned by Giménez Ganga or third parties, with no exploitation rights as recognised by applicable intellectual property standards being transferred to the User. The brands, trade names or distinctive signs also belong to Giménez Ganga, with the understanding that accessing them does not grant any rights the said brands, trade names and/or distinctive signs.

© Copyright 2017. Giménez Ganga, S.L.U.



